

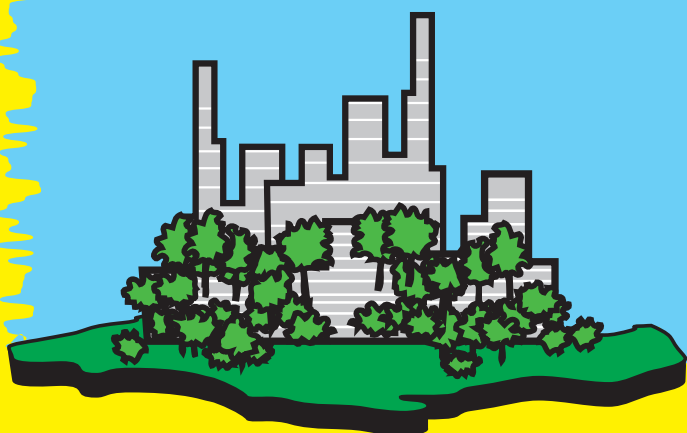

**REDUCE,  
REUSE,  
RECYCLE**  
**CARE FOR OUR  
ENVIRONMENT**

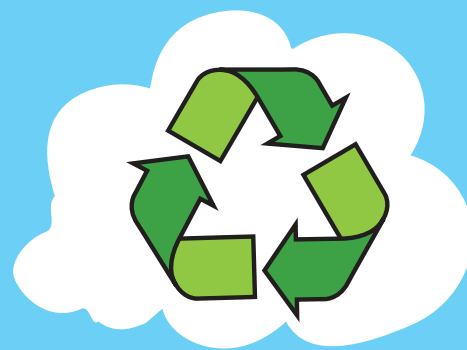

**TEACHER'S GUIDE**

## FOREWORD

It is everyone's responsibility to conserve the limited resources around us for the sustainability of the environment that we currently enjoy. Hence, it is crucial to guide our children to adopt a 3R lifestyle from a young age and nurture them to become an environmentally-responsible generation.

**The Preschool 3R (Reduce-Reuse-Recycle) Awareness Kit** is specially developed by the National Environment Agency (NEA) to educate preschoolers on the importance of adopting a 3R lifestyle. The set of Pictocards and Teacher's Guide, complete with lesson plans and creative hands-on activities, are made available as teaching aids for the programme.

We would like to take this opportunity to extend our appreciation to the dedicated teachers who make the effort to guide the children along this 3R journey. What they impart to the children today will truly go a long way in impacting the future of our environment.

**Together, let's make the 3Rs our way of life!**

## INTRODUCTION TO CAPTAIN GREEN

**Hi! I am  
Captain Green**

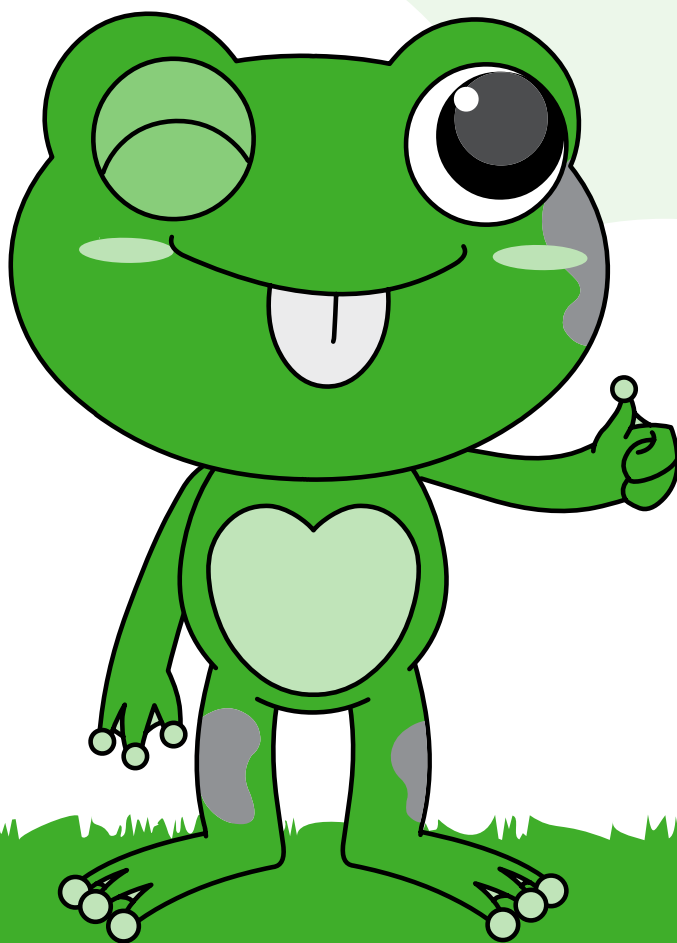

Captain Green is a cheerful frog that loves to play and have fun. He is very sensitive to changes in the environment, and is affected when people do not practise environmentally-friendly habits. He calls out to everyone to protect and care for the environment. One of the ways is to adopt the 3Rs (Reduce, Reuse and Recycle) at home, in school and in public areas.

Be Eco with Captain Green, and join him to explore and learn more about the 3Rs. He will help children understand how they can make a difference to the environment by practising the 3Rs. Together, we can all care for our environment!

## OVERVIEW OF THE PRESCHOOL 3R AWARENESS KIT

### **Objective :**

Objective: The objective of the Preschool 3R Awareness Kit is to educate the young on the waste challenges faced by Singapore and the importance of the 3Rs.

### **Target Group :**

The Preschool 3R Awareness Kit is intended for preschoolers in Kindergarten 1 (5 year olds) and in Kindergarten 2 (6 year olds).

### **Components of the Preschool 3R Awareness Kit:**

The Preschool 3R Awareness Kit comprises:

- a) a teacher's guide and
- b) a set of pictocards as visual aids.

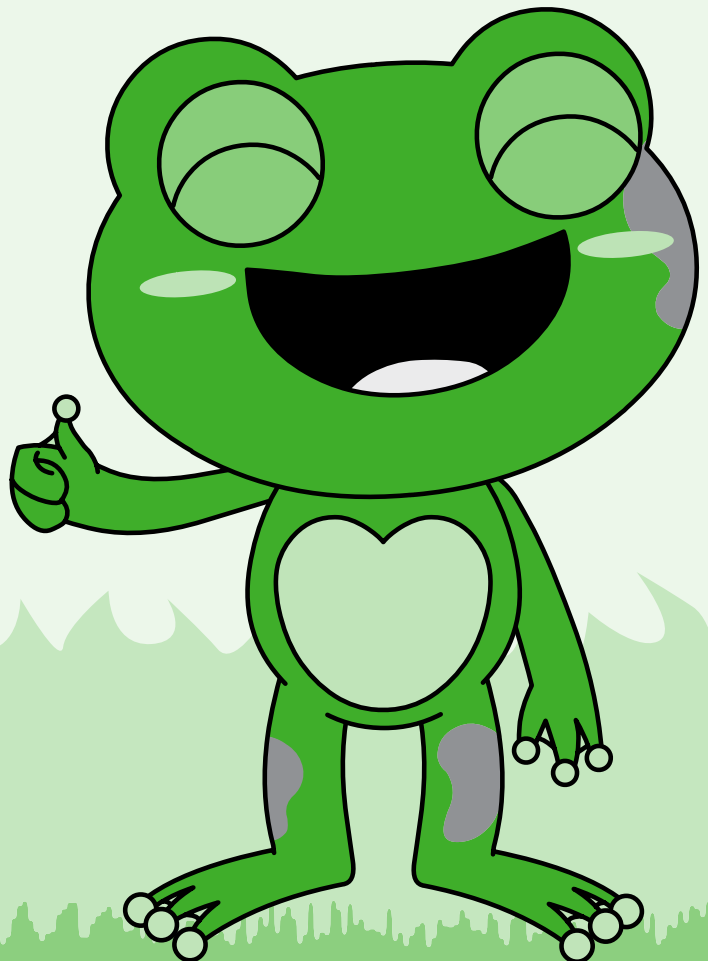

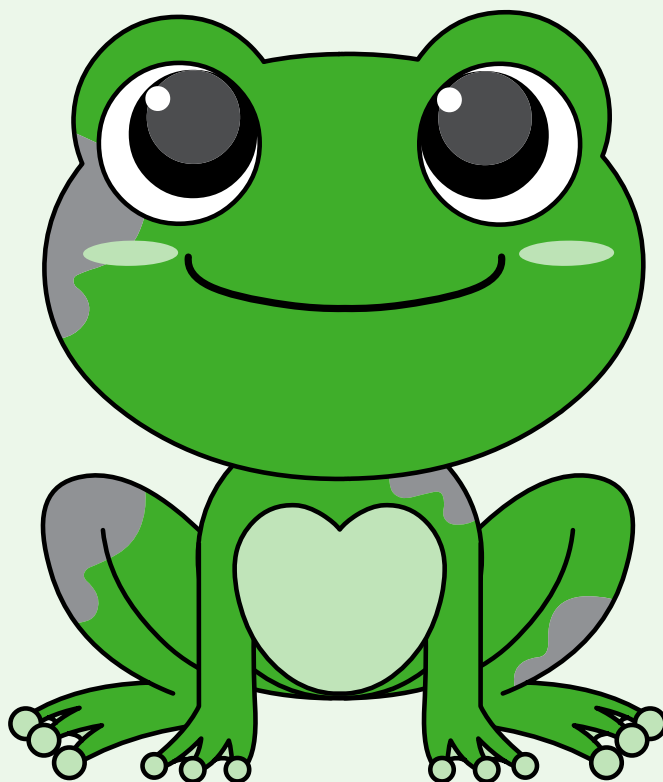

### **Organisation of the materials**

The materials are to be taught over 14 lesson plans in the following manner:

- a) One introductory lesson plan to give the preschoolers a brief overview of the management of waste in Singapore and the waste challenges faced in view of increasing waste generated; and
- b) 13 lesson plans which cover the 3Rs - Reduce, Reuse and Recycle.

The Pictocards are visual aids to be used in class.

In order to allow the teachers to have a better understanding of the teaching materials in the pictocards, each lesson plan in the teacher's guide is structured in the following manner :

- a) The pictocard to use;
- b) Lesson objectives; and
- c) Lesson contents.

The teacher's guide also provides the following supporting materials for each theme :

- a) Additional facts;
- b) Suggested hands-on activities for the pre-schoolers; and
- c) Worksheets.

# CONTENTS

<b>Foreword</b>	<b>i</b>
<b>Introduction to Captain Green</b>	<b>ii</b>
<b>Overview of the Preschool 3R Awareness Kit</b>	<b>iii</b>
Lesson Plan 1 - Introduction to waste and its challenges	1
Additional Fact	2
<i>Activity 1 - The common household waste thrown in the rubbish bin</i>	2
<i>Activity 2 - The materials used to make or package the common household items</i>	2
<i>Worksheet 1 - Trace where the banana skin goes to</i>	3
<i>Worksheet 2 - Fill in the missing letters and colour the pictures</i>	4
<b>THEME : Reduce Waste</b>	<b>5</b>
Lesson Plan 2 - Reduce waste at home	6
Lesson Plan 3 - Reduce waste at school	7
Additional Information	8
<i>Activity 1 - Make your own carrier bag for shopping</i>	8
<i>Activity 2 - Field trip to supermarket</i>	10
<i>Activity 3 - Decorate your own carrier bag with unwanted materials</i>	10
<i>Worksheet 1 - How can you reduce waste at home and at school?         Circle the right thing to do.</i>	11
<b>THEME : Reuse Waste</b>	<b>12</b>
Lesson Plan 4 - Reuse waste at home	13
Lesson Plan 5 - Reuse waste at school	14
Additional Information	15
<i>Activity 1 - 3R mosaic from junk</i>	15
<i>Activity 2 - Make binoculars from empty toilet paper rolls</i>	16
<i>Activity 3 - Make a hat from old newspaper</i>	17
<i>Activity 4 - Make a paper dog from scrap paper</i>	18
<i>Activity 5 - Make a cardboard guitar from unwanted household items</i>	19
<i>Worksheet 1 - Trace the dots to reveal how you can reuse your empty glass         container at home. Colour the picture</i>	20

## **THEME : Recycle Waste**

**21**

Lesson Plan 6 - Why recycle?	22
Lesson Plan 7 - What can be recycled?	23
Lesson Plan 8 - Recycle waste at home	24
Lesson Plan 9 - Recycle waste at school	25
Lesson Plan 10 - After collection of recyclables	26
Lesson Plan 11 - How is paper recycled?	27
Lesson Plan 12 - How is plastic recycled?	28
Lesson Plan 13 - How is glass recycled?	29
Lesson Plan 14 - How are cans recycled?	30
Additional Information	31
<i>Activity 1 - Make your own recycling box for the classroom</i>	31
<i>Activity 2 - Observe how recyclables are collected from the school</i>	34
<i>Activity 3 - Make recycled paper from scrap paper</i>	34
<i>Activity 4 - Trace the paper recycling process</i>	36
<i>Activity 5 - Trace the plastic recycling process</i>	38
<i>Activity 6 - Trace the glass recycling process</i>	40
<i>Activity 7 - Trace the cans recycling process</i>	42
<i>Worksheet 1 - Don't throw me away. Circle and identify the recyclables from the rubbish.</i>	44
<i>Worksheet 2 - Throw the right items into the recycling bin!</i>	45
<i>Answers to Worksheets 1 and 2</i>	46

# LESSON PLAN 1: INTRODUCTION TO WASTE AND ITS CHALLENGES

Pictocard to use : 1



## 1. LESSON OBJECTIVES

This lesson serves to educate the children on

- What waste is;
- How waste can be managed at home; and
- What the waste challenges are.

## 2. LESSON CONTENTS

### ***What is waste? Where does it come from?***

Waste is something that we do not need and throw away. It can be from homes, schools, offices or shopping centres.

### ***How do we manage our waste?***

The waste is burnt in the waste-to-energy incineration plants. What is left after incineration, together with waste that cannot be incinerated, is buried in an offshore landfill at Pulau Semakau, called Semakau Landfill.

### ***What is the main challenge faced by us?***

Not enough land in Singapore to build more incineration plants and landfills.

### ***What should we do to tackle these challenges?***

We can help to tackle these challenges by following Captain Green, who will teach us how to:

- **Reduce** (to avoid having more waste);
- **Reuse** (to use again); and
- **Recycle** (to convert waste into useful recycled products).



## ADDITIONAL FACT

For four decades starting in the early 1970s, our waste disposal has increased by almost 7 times.

Year	Amount of waste generated per day
1970	1,260 tonnes per day
2013	8,289 tonnes per day

## SUGGESTED ACTIVITIES

### Activity 1

The common household waste thrown into the rubbish bin.

**Aim: The children will be able to identify the common types of waste that is thrown at home.**

Bring and show the class some common items that are thrown away at home.

Some of these items (as shown in Pictocards 1) could include :

- Drink cans;**
- Used drink cartons (e.g. packet drink, milk carton);**
- Plastic bottles (e.g. drink bottle, dishwashing detergent bottle);**
- Packaging material (e.g. empty biscuit box, plastic packaging, plastic fruit box); and**
- Paper (e.g. envelope, newspaper, magazine, mailers, tissue box).**

Explain to the children that some of the waste can be reduced, reused and recycled to prolong the lifespan of our only landfill and to avoid building more incineration plants. Practising the 3Rs also conserves natural resources and minimises pollution.

### Activity 2

The materials used to make or package the common household items.

**Aim: The children will be able to identify the types of materials that are used to make or package the items that are commonly found at home.**

Prepare four big sheets of paper with the labels “**PAPER**”, “**PLASTIC**”, “**GLASS**” and “**CANS**”. Divide the class into pairs and distribute a magazine and scissors to each pair.

Ask the children to look for 4 to 6 pictures of objects that they think are used only once and thrown away, and cut them out. Go round the pairs and ask them to paste the pictures under the types of materials which they think is correct. Discuss with the class about the materials that are used to make or package the chosen items.

# WORKSHEET 1

Trace where the banana skin goes to.

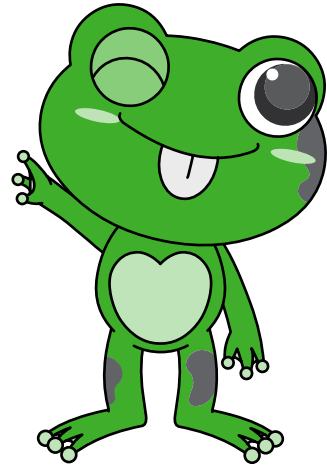

Start point

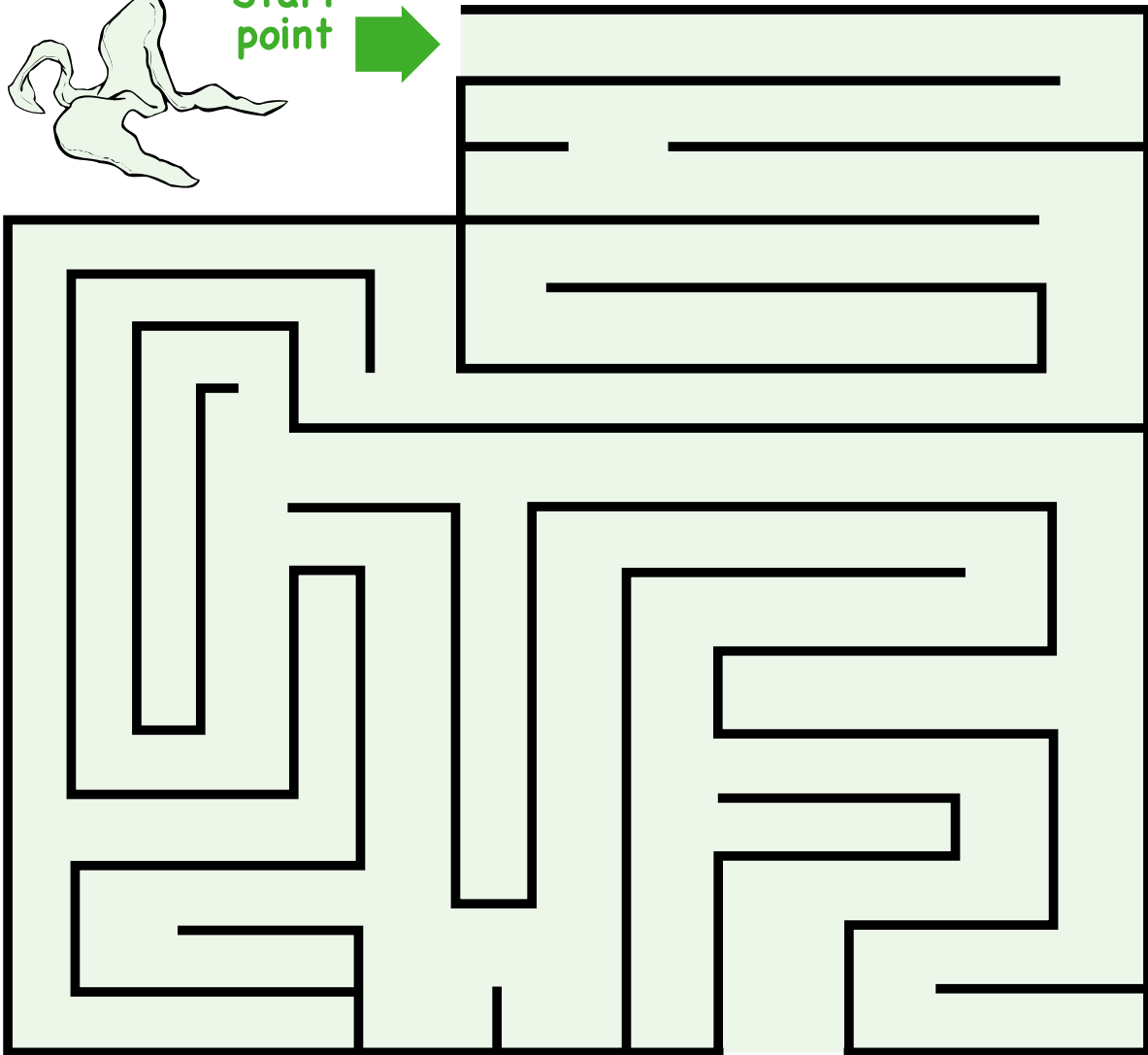

End point

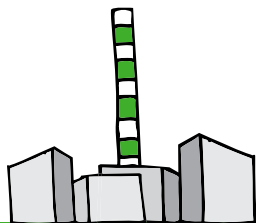

Incineration plant

&



Landfill

# WORKSHEET 2

Fill in the missing letters  
and colour the pictures.

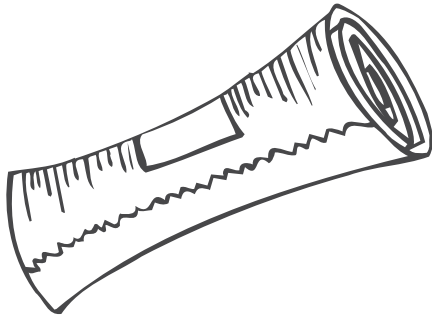
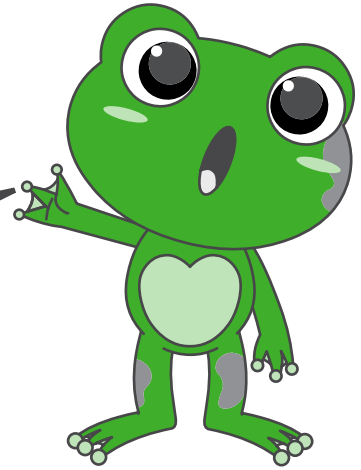

P \_ pe \_

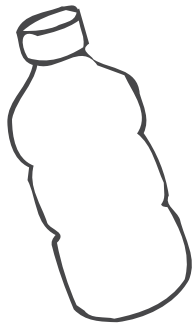

Pl \_ st \_ c



\_ la \_ s

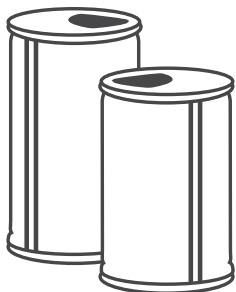

C \_ ns

# REDUCE WASTE

## LESSON PLAN 2 : REDUCE WASTE AT HOME

Pictocard to use : 2



### 1. LESSON OBJECTIVES

This lesson serves to educate the children on :

- What the first R in 3R means; and
- How they can reduce waste at home.

### 2. LESSON CONTENTS

#### ***What does 'Reduce waste' mean?***

To reduce waste is to avoid creating more waste whenever we can.

#### ***How can you help to reduce waste at home?***

- By not taking plastic bags when shopping;
- By bringing your own reusable bag when shopping;
- By choosing rechargeable batteries instead of non-rechargeable batteries for your toys; and
- By buying one 1 litre milk pack instead of four 250ml milk packs to reduce packaging waste.

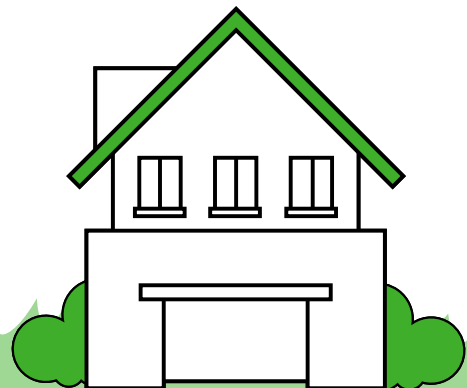

## LESSON PLAN 3 : REDUCE WASTE AT SCHOOL

Pictocard to use : 3



### 1. LESSON OBJECTIVES

This lesson serves to educate the children on :

- What the first R in 3R means; and
- How they can reduce waste at school.

### 2. LESSON CONTENTS

#### ***What does 'Reduce waste' mean?***

To reduce waste is to avoid creating more waste whenever we can.

#### ***How can you help to reduce waste at school?***

- By bringing your own snacks in your own takeaway box instead of buying a snack to avoid having containers or wrappers that would be thrown away later;
- By bringing your own water bottle to school instead of buying a drink, to avoid having an empty bottle or drink can that would be thrown away later; and
- By using both sides of paper for drawing and writing.

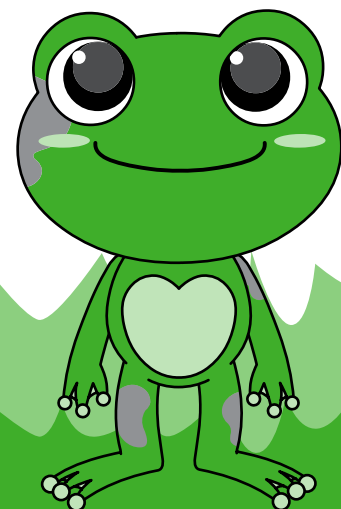

## ADDITIONAL INFORMATION

### #1: Other ways we can help to reduce waste at home

- Plan a shopping list to prevent purchasing on impulse;
- Purchase things with less packaging; and
- Purchase refillable packs for items like dishwashing liquid.

### #2: Other ways we can help to reduce waste at school

- Purchase refillable items e.g. mechanical pencils and refillable pens;
- Do not over-cater drinks and food for school activities and events; and
- Purchase more durable devices and items e.g. plastic folders instead of paper folders.

### #3: Plastic bags

- About 3 billion<sup>1</sup> plastic bags are used in Singapore every year.
- Plastic bags are made from oil, a finite resource. By using reusable bags during our shopping trips, we will use fewer plastic bags and help to conserve earth's limited resources; and
- Plastic bags are not disposed of at Semakau Landfill. They are incinerated, along with other domestic wastes, at our four waste-to-energy incineration plants.

## SUGGESTED ACTIVITIES

### Activity 1

Make your own carrier bag for shopping.

**Aim:** The children will be able to reduce use of plastic bags by making their own carrier bags for shopping.

Main materials needed : **Scrap paper, cardboard, string** (could be unwanted shoelace), **glue** and **scissors**.

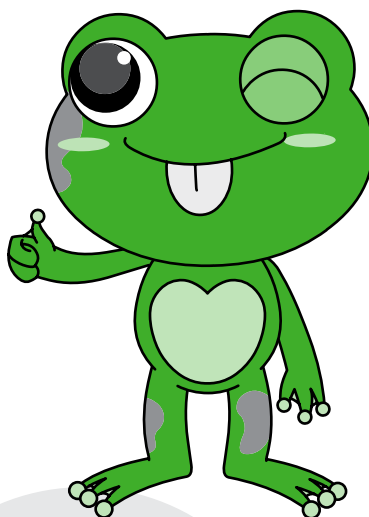

The teacher can prepare **Step 1** and **Step 2** before the activity. Each child to be given the prepared materials and the teacher to guide the children throughout the activity.

**Procedure :**

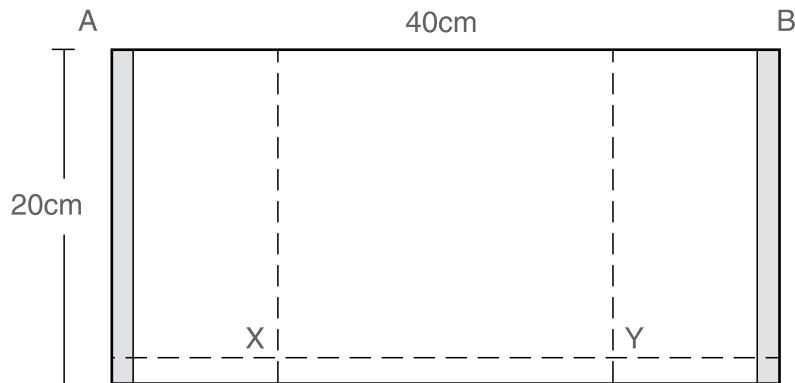

- Step 1** Cut a piece of strong scrap paper measuring 20 cm by 40 cm.
- Step 2** Draw out dotted lines as shown above.

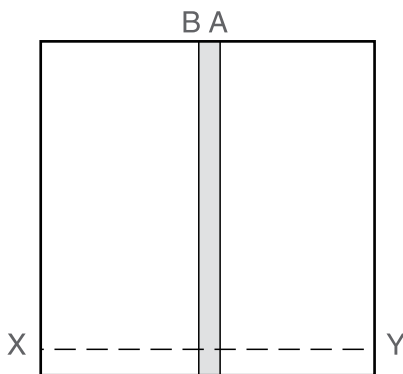

- Step 3** Fold the paper along the dotted lines.
- Step 4** Use glue to stick the shaded area A and B together

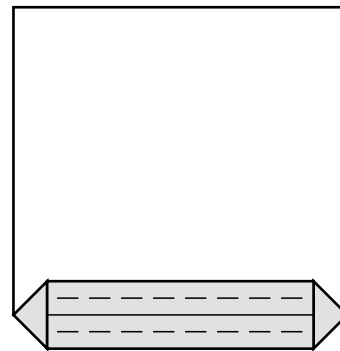

- Step 5** After folding along the dotted line XY, open up the base.
- Step 6** Fold along the dotted lines as shown above. Use glue to fasten the shaded part.

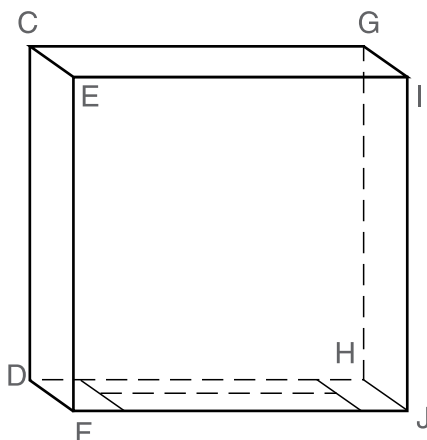

- Step 7** Open up the carrier bag.
- Step 8** Fold along the lines CD, EF, GH and IJ.
- Step 9** Cut a piece of cardboard of the same dimensions as the base DHJF and place it inside the bag.

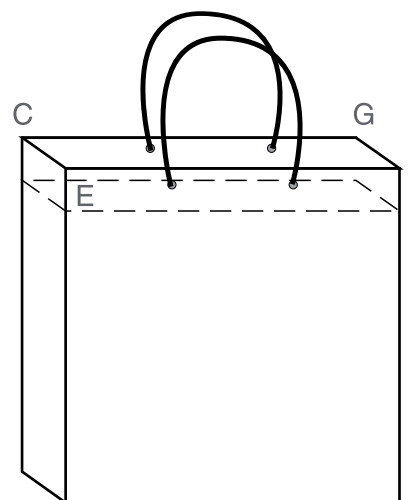

- Step 10** Cut another two long pieces of cardboard of about 3cm in width and stick along the folds CG and EI. This is to reinforce the top of the bag for the handles.
- Step 11** Punch two holes each along CG and EI.
- Step 12** Attach string through the holes for the bag handles.

**Figure 1 – Template for carrier bag**



### Activity 2

As a follow-up to Activity 1, the teacher could arrange for the children to go to a nearby supermarket. The children would use their carrier bags to put the purchase items instead of asking for plastic bags.

### Activity 3

Decorate your own carrier bag with unwanted materials.

**Aim : The children will be taught to reduce waste by using some small unwanted items as decorations for their carrier bags instead of throwing them away.**

Main materials needed : **small unwanted items** (brought from home by students), **glue, sticky tape, crayons and other colouring materials**, etc.

The teacher can ask the children to bring from home small unwanted materials that can be used to decorate their own carrier bag which was made from Activity 1. Some of such unwanted materials could be :

- a) **Buttons;**
- b) **Ribbons;**
- c) **Coloured paper;**
- d) **Strings; and**
- e) **Paper clips.**

The child can add in the final touches by colouring the bag and adding in the message “Bring My Own Bag”.

Alternatively, the teachers can prepare the required numbers of bags (**see Activity 1**) before the activity. Distribute the bags to the children to decorate the bags using the materials they have brought from home.

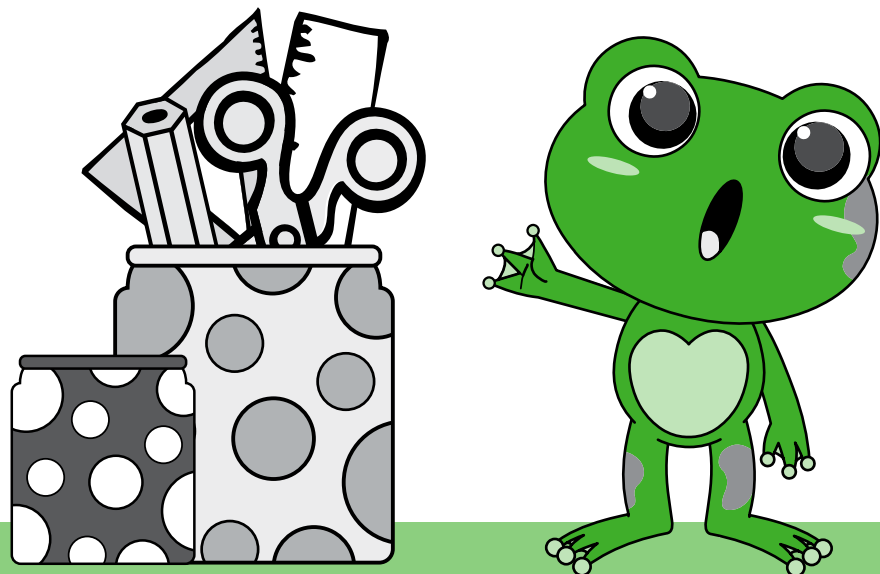

# WORKSHEET 1

How can you reduce waste at home and at school?  
Circle the right thing to do.

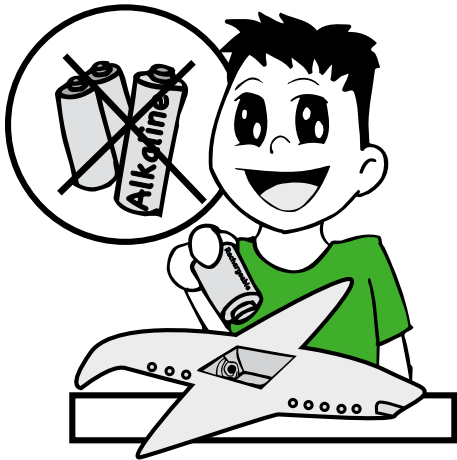
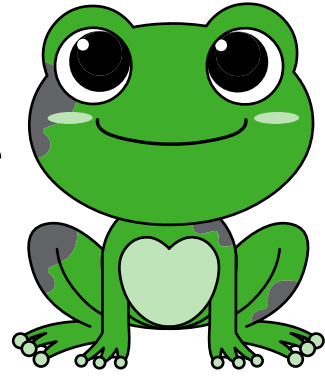

# REUSE WASTE

## LESSON PLAN 4 : REUSE WASTE AT HOME

Pictocard to use : 4



### 1. LESSON OBJECTIVES

This lesson serves to educate the children on :

- What the second R in 3R means; and
- How they can reuse waste at home.

### 2. LESSON CONTENTS

#### ***What does 'Reuse waste' mean?***

To use again an item that has been used before.

#### ***How can you help to reuse waste at home?***

- By reusing used plastic bags to line the rubbish bin;
- By reusing plastic or glass containers as flower vases or pencil holders;
- By reusing old unwanted clothes (eg. shirt, towel) for cleaning; and
- By giving away old books instead of throwing them away.



## LESSON PLAN 5 : REUSE WASTE AT SCHOOL

Pictocard to use : 5



### 1. LESSON OBJECTIVES

This lesson serves to educate the children on :

- What the second R in 3R means; and
- How they can reuse waste at school.

### 2. LESSON CONTENTS

#### ***What does 'Reuse waste' mean?***

To use again an item that has been used before.

#### ***How can you help to reuse waste at school?***

- By making toys out of empty tissue boxes;
- By making storage boxes out of old cardboard cartons for toys and books; and
- By making handicraft out of scrap papers.

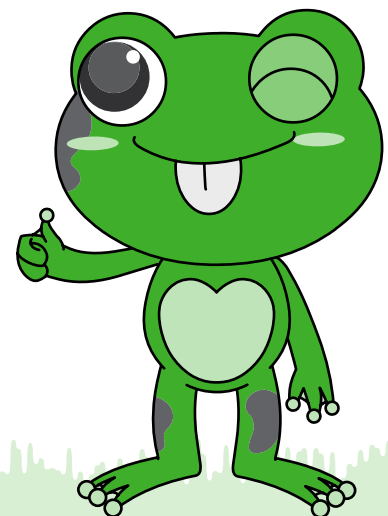
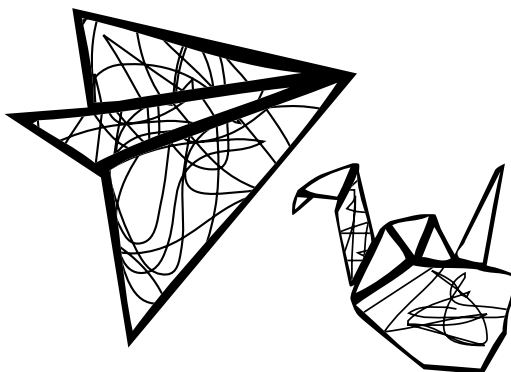
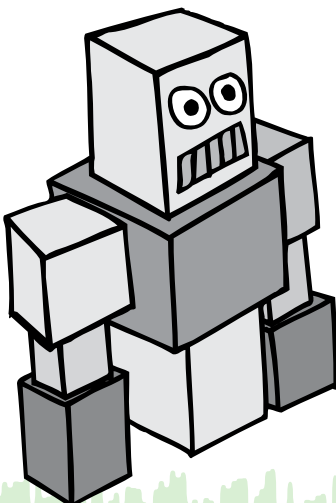

## ADDITIONAL INFORMATION

### #1: Other ways we can help to reuse waste at home

- Convert scrap paper into memo paper; and
- Clean and reuse washable cutlery and crockery for the next party.

### #2: Other ways we can help to reuse waste at school

- Donate old story books; and
- Reuse plastic and glass containers as pots for plants.

## SUGGESTED ACTIVITIES

### Activity 1

3R mosaic from junk.

**Aim: The children will be able to reuse old materials and creatively make a 3R art mosaic.**

Main materials needed : **Old unwanted cardboard, junk materials, glue, sticky tape.**

Each child is to bring 3 to 4 colourful small pieces of 'junk materials' (e.g. unwanted buttons, clips, bottle caps, toy parts, etc.) from home. The whole class will glue the materials together on a board to create a colourful and attractive 3R mosaic.

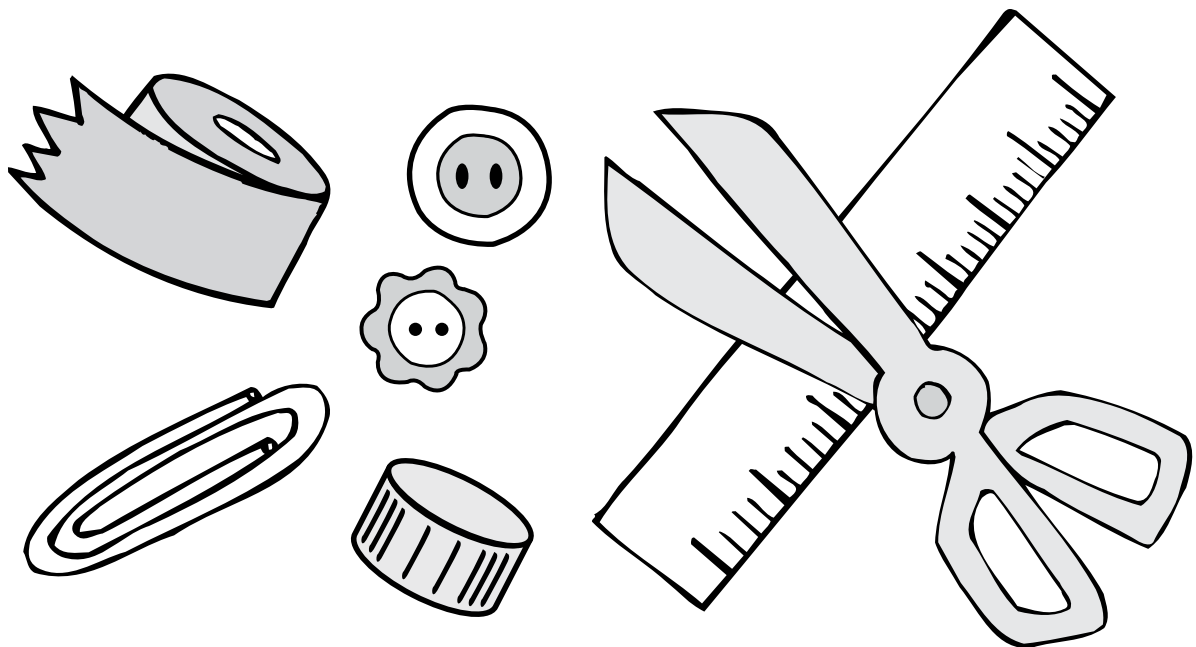

## Activity 2

Make binoculars from empty toilet paper rolls.

**Aim :** The children will be able to reuse unwanted household items to make creative art.

Main materials needed : **2 empty toilet paper rolls**, a piece of aluminium foil, a piece of **string** (could be an old shoelace) and **glue or sticky tape**.

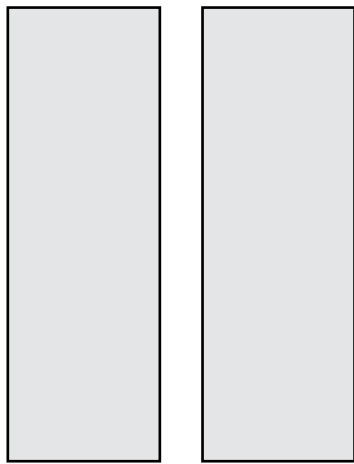

**Step 1** Cut the aluminium foil into two equal strips (enough to cover the toilet roll).

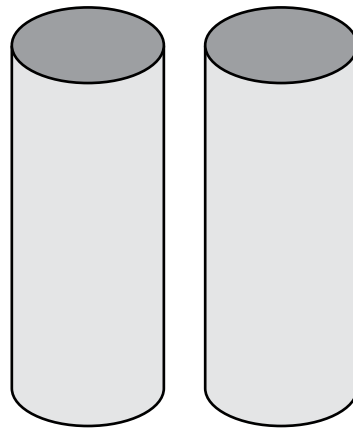

**Step 2** Wrap each empty toilet roll with the aluminium foil and smooth the foil firmly over the toilet roll.

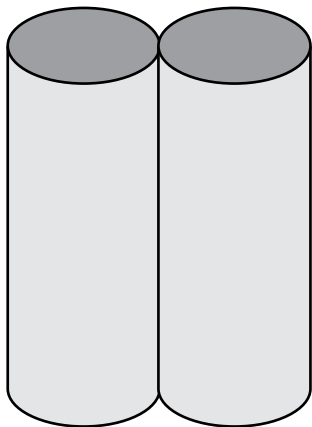

**Step 3** Paste the two toilet paper rolls together lengthwise with glue or sticky tape.

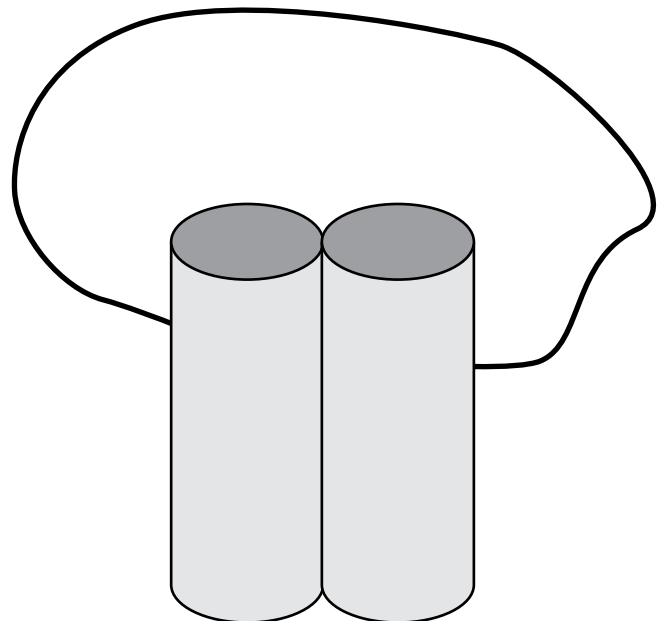

**Step 4** Pierce a hole through the outside of each toilet roll near the end and tie a string through the holes. Make sure the string is long enough to allow the binoculars to be hung from the neck.

### Activity 3

Make a hat from old newspaper.

**Aim : The children will be able to reuse unwanted household items to make creative art.**

Main materials need : **One piece of old newspaper** and **sticky tape**.

(Use a smaller sized newspaper or cut the larger newspaper smaller to reduce the size of the paper hat).

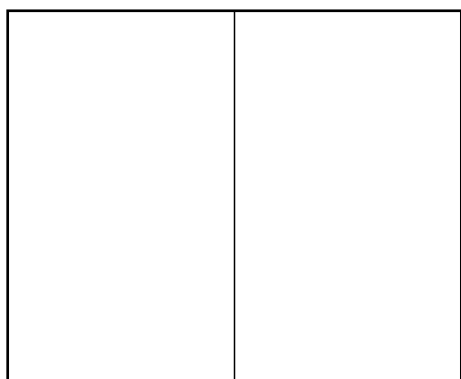

**Step 1** Open up the newspaper.



**Step 2** Fold the sheet of newspaper in half vertically.



**Step 3** Fold the newspaper in half horizontally and firmly to form the fold line.

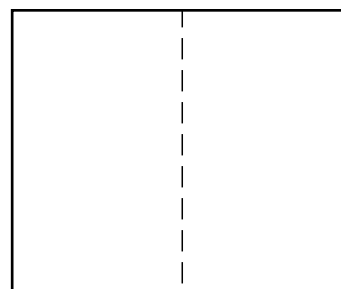

**Step 4** Open up the last fold and turn the newspaper with the longer side facing you.

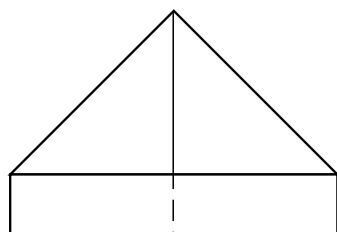

**Step 5** Fold each of the left and right top corners down to the centre line.

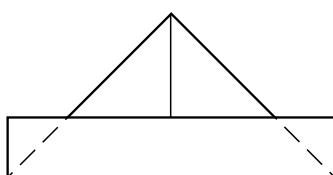

**Step 6** Fold the front bottom flap up and crease well. Flip to the other side and repeat the step.

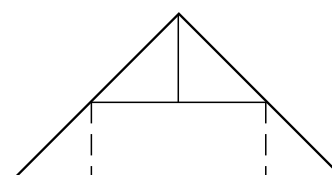

**Step 7** Tuck the corner neatly behind the body of the paper hat and crease well. Turn over to other side and repeat the step. Use sticky tape to hold the four corners. Open up the bottom base of the hat.



## Activity 4

Make a paper dog from scrap paper.

**Aim :** The children will be able to reuse unwanted household items to make creative art .

Main materials need : **One piece of square scrap paper, two old buttons** (of the same kind), **a black marker, glue/sticky tape.**

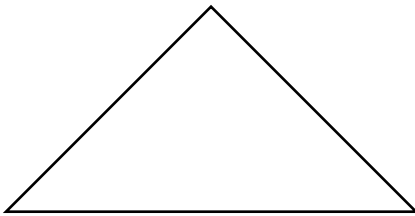

**Step 1** Fold the square paper diagonally into half firmly to form a fold line.

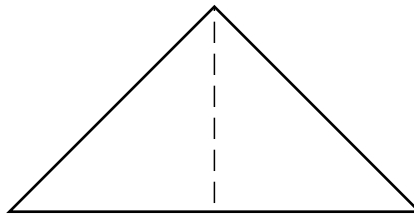

**Step 2** Fold the triangle into half firmly again and open up the last fold.

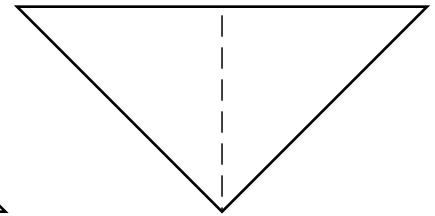

**Step 3** Turn the tip of the triangle to face you.

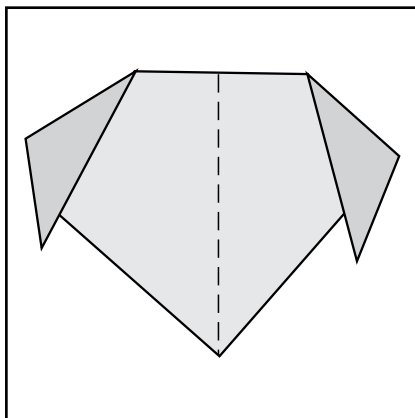

**Step 4** Fold the left and right hand corner at an angle to form the ears of the dog.

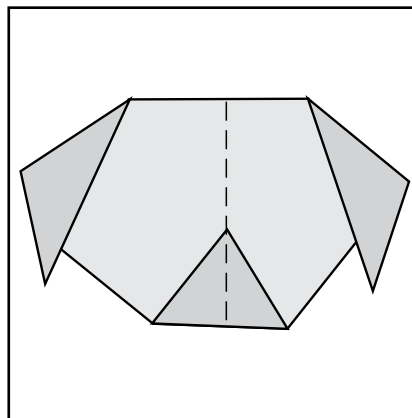

**Step 5** Fold the bottom tip of the triangle (about one third of the middle crease line) to form the nose of the dog.

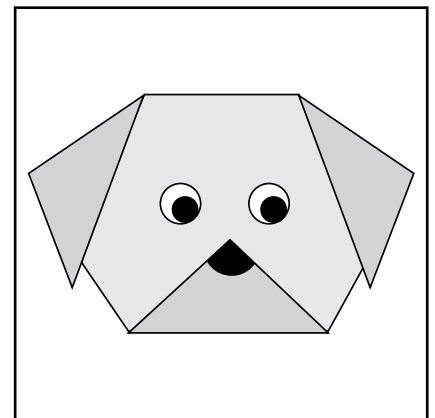

**Step 6** Colour the tip of the nose black with the marker. Glue or stick the two buttons as eyes for the dog. Alternatively, draw the eyes using the black marker.

### Activity 5

Make a cardboard guitar from unwanted household items.

**Aim : The children will be able to reuse unwanted household materials to make toy musical instruments.**

Main materials needed : **empty tissue box, toilet roll, 4 elastic bands, paint, sticky tape and glue.**

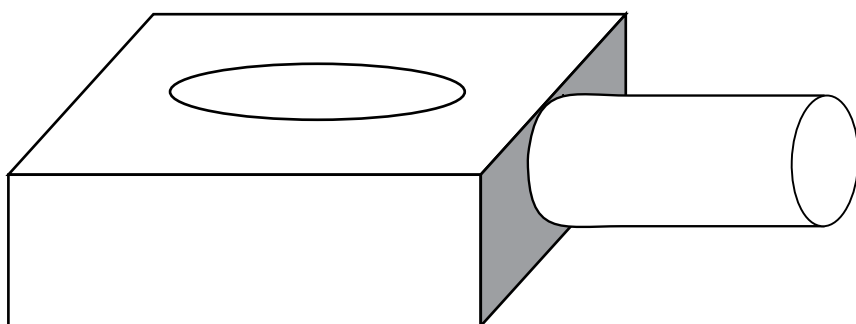

**Step 1** Remove the plastic flap, if any, at the opening of the tissue box. Glue the toilet roll to the side of the tissue box. Use sticky tape to secure the joint.

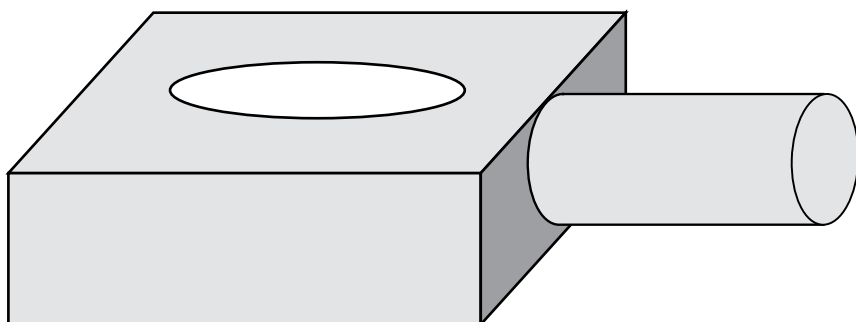

**Step 2** Paint the tissue box and the toilet roll with different colours.

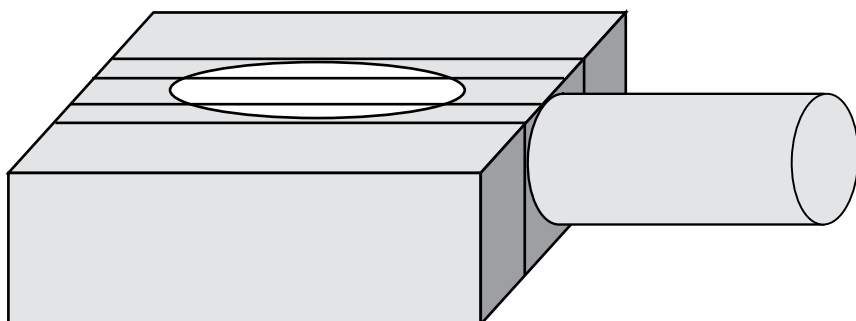

**Step 3** Wait for the paint to dry and stretch the elastic bands across the tissue box. Put a sticky tape to hold the elastic bands to the box.

# WORKSHEET 1

Trace the dots to reveal how you can do your part to reuse your glass container at home. Colour the picture.

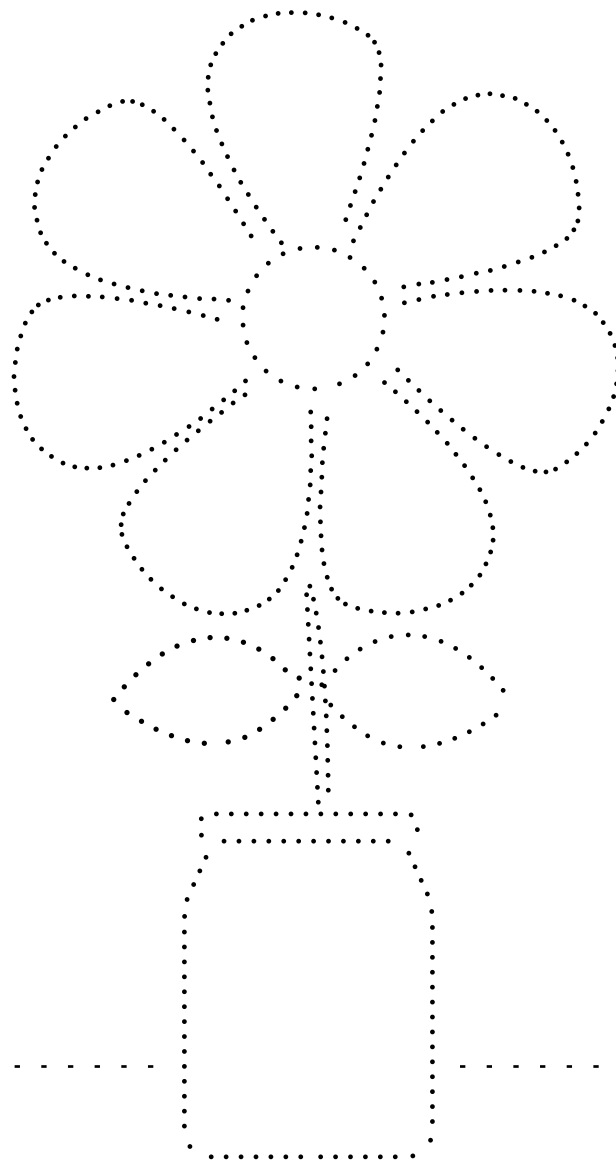
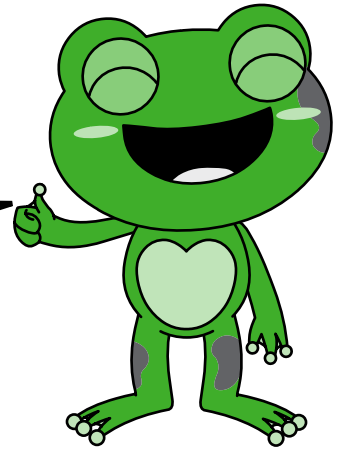

Reuse an empty glass jar as a vase for flowers at home.